

Article number: 2030100M1675A2U

Description: E+G levelling foot
GN 30-100-M16-75-A2-U

Note: U Without nut, Hexagon socket at the top, Wrench flat at the bottom

Measures

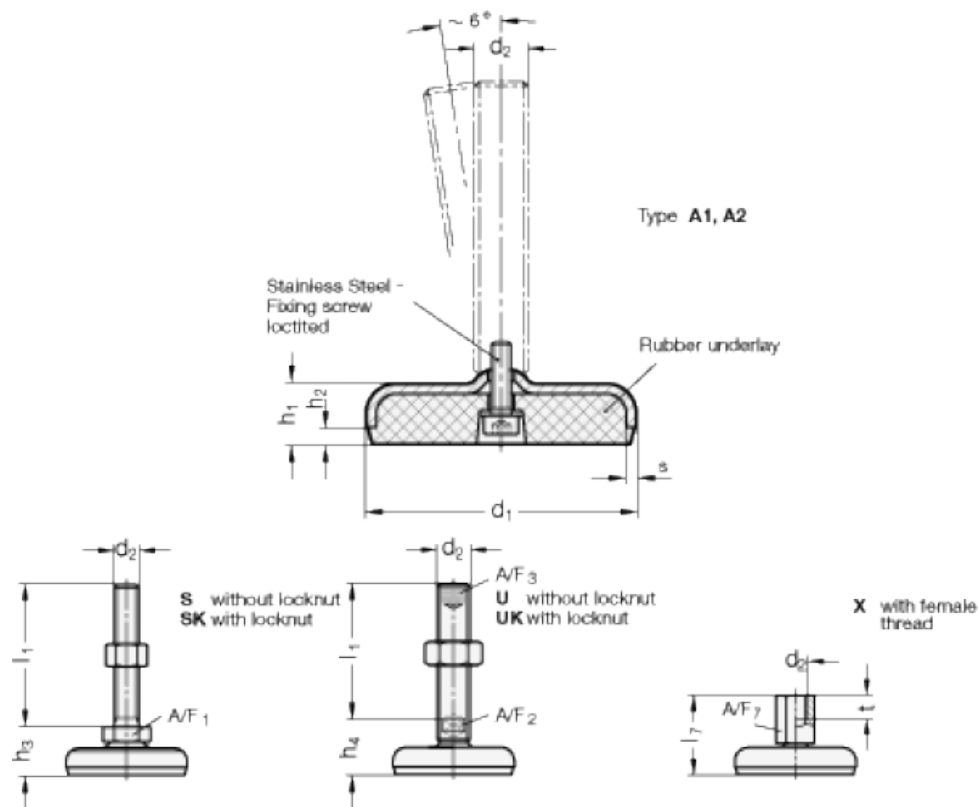

A/F2 = 12

s = 3

A/F3 = 8

d1 = 100

d2 = M16

h1 = 20

h2 = 6

h4 = 34

l1 = 75